



# MORAL

HIERROS Y FERRALLA

## FORJA



 Las imágenes y colores son una representación aproximada y no exacta



cubierta



fachada

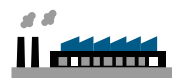

Chapas • Mallazo • Tubos • Corrugados • Pletinas • Vigas • Postes y Vallas  
Panel para Cubiertas en Stock • Forja • Peldaños de Escalera • Ferralla  
Puertas Metálicas • Corte de vigas para estructuras metálicas

# FORJA WROUGHT IRON

## ÍNDICE / INDEX

ACCESORIOS / ACCESSORIES

ROLEOS / SCROLLS

ADORNOS / ORNAMENTS

P. DE LANZAS / SPEARS

BARRAS Y PASAMANOS / BARS AND HANDRAILS

ARRANQUES / STARTING POINTS FOR STAIRCASES

BALAUSTRÉS / BANISTERS

SOLERAS / BORDERS

PENACHOS Y MÉNSULAS / PINACLES AND BRACKETES

ADORNOS DE CANCELA / GATE ORNAMENTS

HERRAJES / IRONWORKS



Todas las medidas de este catálogo de muestras son aproximadas, la empresa se reserva el derecho de modificarlas sin previo aviso.

# ACCESORIOS ACCESSORIES



BxH: 70x60  $\varnothing$ 3

Ref. FVA001



BxH: 70x60  $\varnothing$ 3

Ref. FVA002



BxH: 50x120

Ref. FVA014



BxH: 50x120

Ref. FVA015



BxH: 40x105  $\varnothing$ 3

Ref. FVA004



BxH: 40x105  $\varnothing$ 3

Ref. FVA005



BxH: 60x165  $\varnothing$ 3

Ref. FVA007



BxH: 60x165  $\varnothing$ 3

Ref. FVA008



B: 53  $\varnothing$ 1.5

Ref. FVA016



BxH: 37x80  $\varnothing$ 0.5

Ref. FVA017



BxH: 95x105  $\varnothing$ 0.5

Ref. FVA018



BxH: 65x130  $\varnothing$ 0.5

Ref. FVA019

# ACCESORIOS ACCESSORIES

Mod. Patentado en CE



BxH:69x106∅3

Ref. FVA032

Mod. Patentado en CE



BxH:69x106∅3

Ref. FVA033



B:65∅3

Ref. FVA003



B:65;95∅3

Ref. FVA030P;G



B:87∅3

Ref. FVA012



B:90∅2

Ref. FVA012H



BxH:82x40

Ref. FVA020



B:62∅4

Ref. FVA029

Mod. Patentado en CE

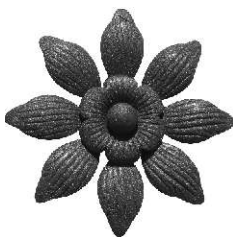

B:120;150∅2.5

Ref. FVA021P;G



B:45

Ref. FVA022



B:90

Ref. FVA023



B:62∅2

Ref. FVA031

# ACCESORIOS ACCESSORIES



B:40

Ref. FVA034



B:40

Ref. FVA035



B:60

Ref. FVA036



B:45

Ref. FVA037



B:50

Ref. FVA038



∅12;14;16;20;24;30

Ref. FVA006



BxH:45x44∅16

Ref. FMA050



BxH:45x67∅16

Ref. FMA051



BxH:40x22∅16

Ref. FMA052



BxH:47x55∅16

Ref. FMA053



BxH:40x40∅16

Ref. FMA054



BxH:40x68∅16

Ref. FMA055

# ACCESORIOS ACCESSORIES

## HUECA



Ø 15; 20; 25; 30; 40; 50; 60  
70; 80; 100; 120

Ref. FRE001



Ø 30; 40; 50

Ref. FRE003



Ø 30; 40; 50; 60  
80; 100; 120

Ref. FRE007



Ø 30; 40; 50; 60  
80; 100; 120

Ref. FRE008



H: 40; 50 Ø 14; 16

Ref. FRE009



H: 120 Ø 75

Ref. FRE002



H: 130 Ø 75

Ref. FRE004



H: 45; 62; 75; 90  
Ø 30; 48; 52; 65

FRE005 S; P; M; G

Mod. Patentado en CE



H: 95 Ø 66

Ref. FRE006



BxH: 40x75; 60x105

Ref. FRE013P;G



BASE Ø	BOLA Ø
40	40
60	60
80	80
100	100

Ref. FRE010



BASE Ø	BOLA Ø
40	40
50	50
60	60
80	80
100	100

Ref. FRE011

# ACCESORIOS ACCESSORIES



B:  $\varnothing$  50;60;90;100;120  
H: 85;85;130;140;145  
E:  $\varnothing$  2

Ref. FRE012



B: 40;50;60;80;100

Ref. FVA024



B: 40;50;60;80;100

Ref. FVA039



B: 40x40  $\varnothing$  12;14;16  
B: 60x60  $\varnothing$  25  
B: 80x80  $\varnothing$  30;40

Ref. FBS001



B: 80x80 S/Taladro

Ref. FBS002



B: 60  $\varnothing$  25

Ref. FBS003



B: 40  $\varnothing$  14;16  
60  $\varnothing$  30

Ref. FBS004



B: 50  $\varnothing$  16  
75  $\varnothing$  25

Ref. FBS005

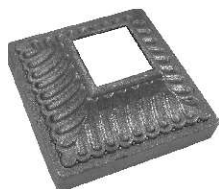

B: 50  $\varnothing$  14;16  
B: 80  $\varnothing$  25  
B: 97  $\varnothing$  30

Ref. FBS006



B: 100  $\varnothing$  25;30

Ref. FBS008

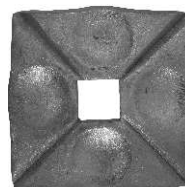

B: 50x50  $\varnothing$  12;14    B: 70x70  $\varnothing$  16  
B: 90x90  $\varnothing$  20    B: 110x110  $\varnothing$  25;30

Ref. FBS009

# ACCESORIOS ACCESSORIES

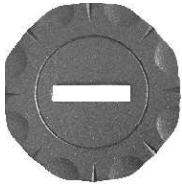

B:90  $\varnothing$ 42x10  
E:4

Ref. FBS007



BxH:10x25 $\varnothing$ 6  
18x33 $\varnothing$ 10

Ref. FVA040P;G



BxH:50x50 $\varnothing$ 3

Ref. FVA027



R:100;115;130  
 $\varnothing$  12x6;16x6

Ref. FVA026



H:200

Ref. FVA025



H:180

Ref. FVA028



BxH:160x450 $\varnothing$ 16

Ref. FPM001



BxH:160x450 $\varnothing$ 16

Ref. FPM002



B:280 $\varnothing$ 20

Ref. FT001



B:320 $\varnothing$ 30

Ref. FT002



B:350 $\varnothing$ 30

Ref. FT003



BxH:85x330

Ref. FT004



## ROLEOS SCROLLS



BxH: 50x230  $\varnothing$ 14x6; 16x6

Ref. FE001



BxH: 70x250  $\varnothing$ 14x6; 16x6

Ref. FE002



BxH: 60x450  $\varnothing$ 14x6; 16x6

Ref. FE003



BxH: 110x270  $\varnothing$ 14x6; 16x6

Ref. FE004



BxH: 130x330  $\varnothing$ 14x6; 16x6

Ref. FS001



BxH: 120x290  $\varnothing$ 14x6; 16x6

Ref. FS003



BxH: 115x230  $\varnothing$ 14x6; 16x6

Ref. FS004



BxH: 80x180  $\varnothing$ 14x6; 16x6

Ref. FS005



BxH: 120x360  $\varnothing$ 16x4

Ref. FS007



BxH: 120x290  $\varnothing$ 16x4

Ref. FS008



BxH: 120x220  $\varnothing$ 16x4

Ref. FS009



BxH: 80x180  $\varnothing$ 8x8

Ref. FS002

# ROLEOS SCROLLS



BxH: 80x150  $\varnothing$ 14x6; 16x6

Ref. FC001



BxH: 70x120  $\varnothing$ 14x6; 16x6

Ref. FC003



BxH: 60x110  $\varnothing$ 14x6; 16x6

Ref. FC004



BxH: 80x115  $\varnothing$ 8x8

Ref. FC002



BxH: 125x200  $\varnothing$ 12x6

Ref. FC005



BxH: 125x200  $\varnothing$ 12x6

Ref. FC006



BxH: 150x205  $\varnothing$ 12x6

Ref. FC007

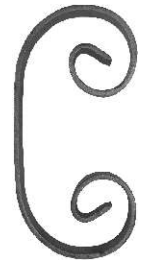

BxH: 60x115; 90x180  
 $\varnothing$  16x4

Ref. FC009P;G

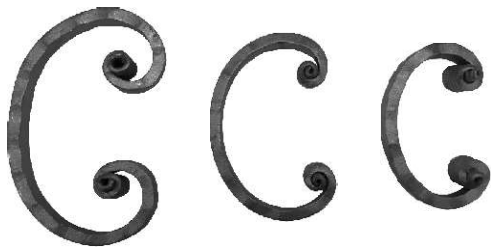

BxH: 65x115; 80x125; 100x160  $\varnothing$  16x8

Ref. FC008P; M; G



BxH: 305x490  $\varnothing$ 12

Ref. FC010



BxH: 305x490  $\varnothing$ 12

Ref. FC011

# ADORNOS ORNAMENTS



BxH: 105x155  $\varnothing$  16x6

Ref. FL001



BxH: 105x155  $\varnothing$  16x6

Ref. FL002



BxH: 95x100  $\varnothing$  16x6

Ref. FAD001

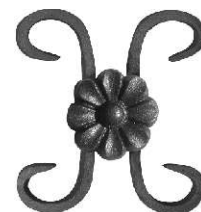

BxH: 95x105  $\varnothing$  16x5

Ref. FAD002

Mod. Patentado en CE



BxH: 109x177  $\varnothing$  16x5

Ref. FAD003

Mod. Patentado en CE

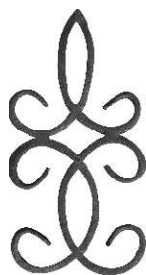

BxH: 109x220  $\varnothing$  16x5

Ref. FAD004

Mod. Patentado en CE



BxH: 109x310  $\varnothing$  16x5

Ref. FAD005

Mod. Patentado en CE

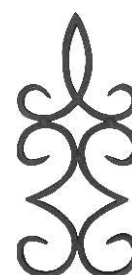

BxH: 109x242  $\varnothing$  16x5

Ref. FAD006



BxH: 230x445  $\varnothing$  16x6

Ref. FAD007

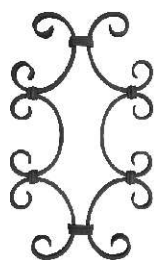

BxH: 235x380  $\varnothing$  16x6

Ref. FAD008

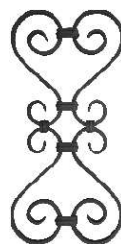

BxH: 200x410  $\varnothing$  16x6

Ref. FAD009

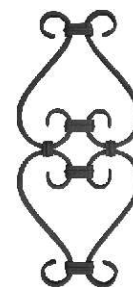

BxH: 165x360  $\varnothing$  16x6

Ref. FAD010

# ADORNOS ORNAMENTS

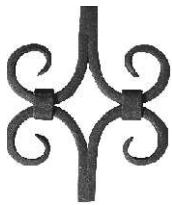

BxH: 130x150  $\varnothing$ 16

Ref. FAD011



BxH: 195x195  $\varnothing$ 16

Ref. FAD012



BxH: 125x360  $\varnothing$ 16

Ref. FAD014



BxH: 195x400  $\varnothing$ 16

Ref. FAD026

Mod. Patentado en CE



BxH: 205x220  $\varnothing$ 16

Ref. FAD027



BxH: 185x185  $\varnothing$ 16

Ref. FAD028



BxH: 205x210  $\varnothing$ 16

Ref. FAD029



BxH: 109x220  $\varnothing$ 16x5

Ref. FAD015

Mod. Patentado en CE

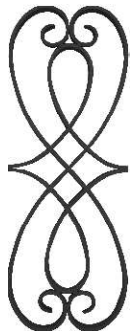

BxH: 180x500  $\varnothing$ 16x6

Ref. FAD016



BxH: 130x400  $\varnothing$ 12

Ref. FAD017

Mod. Patentado en CE



BxH: 160x430  $\varnothing$ 16x6

Ref. FAD018



BxH: 126x366  $\varnothing$ 14

Ref. FAD019

# ADORNOS ORNAMENTS

Mod. Patentado en CE

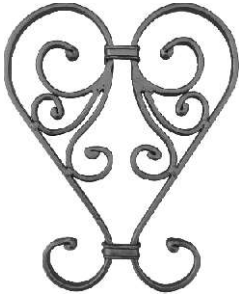

BxH: 235x285  $\varnothing$  16x6

Ref. FAD044

Mod. Patentado en CE



BxH: 235x255  $\varnothing$  16x6

Ref. FAD045

Mod. Patentado en CE



BxH: 160x430  $\varnothing$  12x6

Ref. FAD047

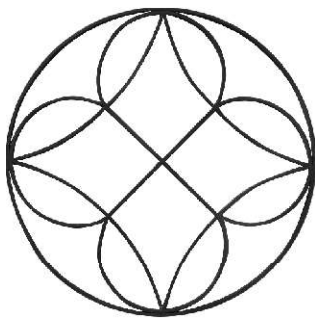

BxH: 600x600  $\varnothing$  16x6

Ref. FAD020

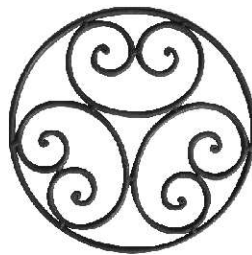

BxH: 500x500  $\varnothing$  14

Ref. FAD021

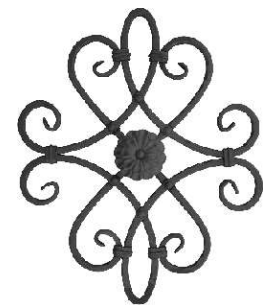

BxH: 425x525  $\varnothing$  12

Ref. FAD022

Mod. Patentado en CE

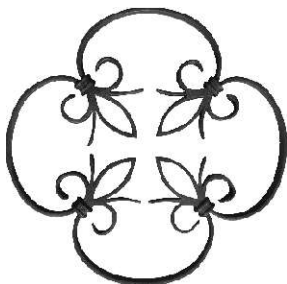

BxH: 420x420  $\varnothing$  16x6

Ref. FAD023

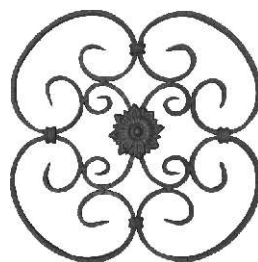

BxH: 360x360  $\varnothing$  16x6

Ref. FAD024

Mod. Patentado en CE



BxH: 450x450  $\varnothing$  12

Ref. FAD025

# ADORNOS ORNAMENTS

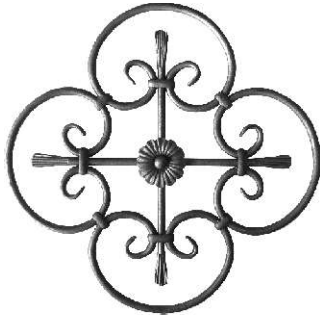

BxH:565x565Ø14

Ref. FAD030

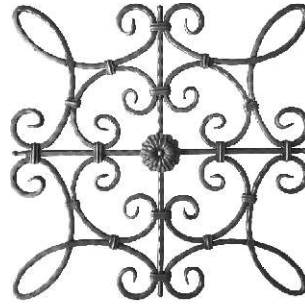

BxH:660x660Ø12

Ref. FAD031

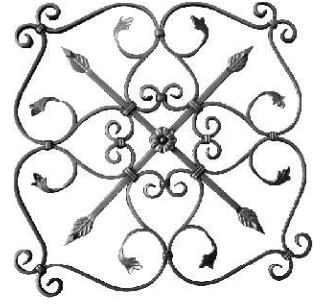

BxH:700x700Ø16x8

Ref. FAD043

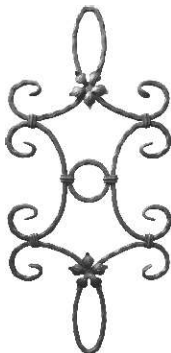

BxH:385x800Ø12

Ref. FAD032

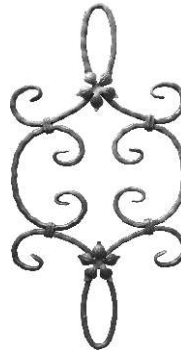

BxH:380x755Ø12

Ref. FAD033

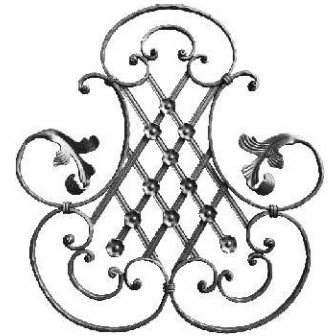

BxH:650x710Ø16x8

Ref. FAD034

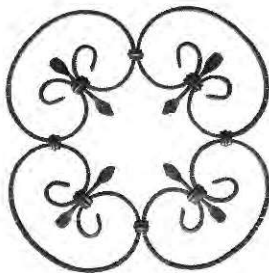

BxH:380X380Ø10x5

Ref. FVA009

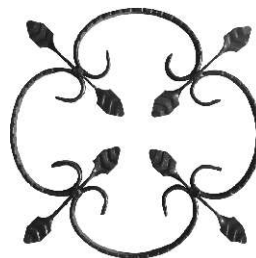

BXH:250X250Ø20x4

Ref. FVA010

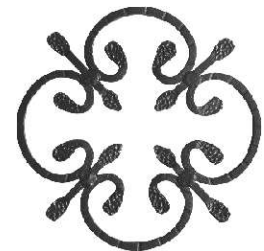

BXH:250X250Ø8

Ref. FVA011

## ADORNOS ORNAMENTS

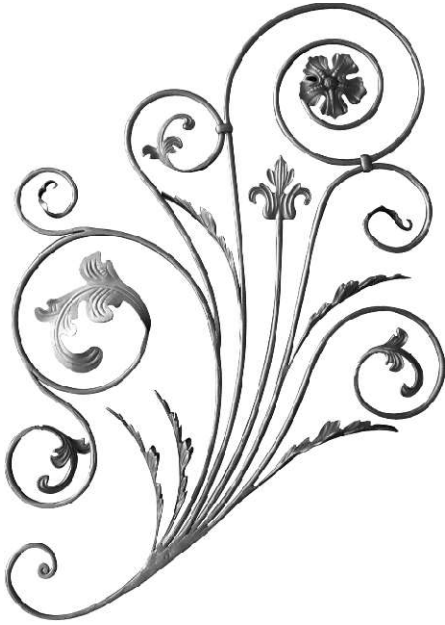

BxH: 740x1060 Ø12

Ref. FAD035

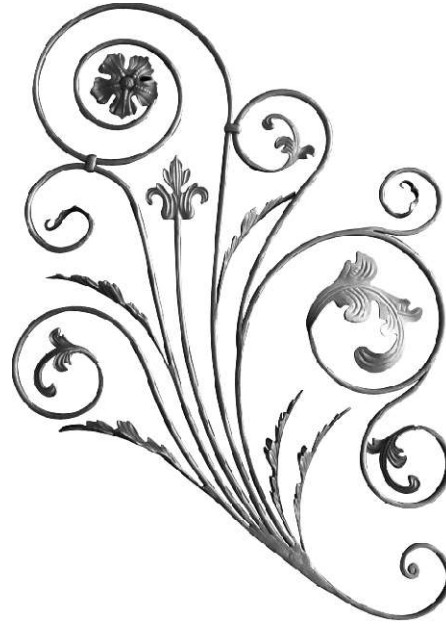

BxH: 740x1060 Ø12

Ref. FAD036



BxH: 800x880 Ø12

Ref. FAD037

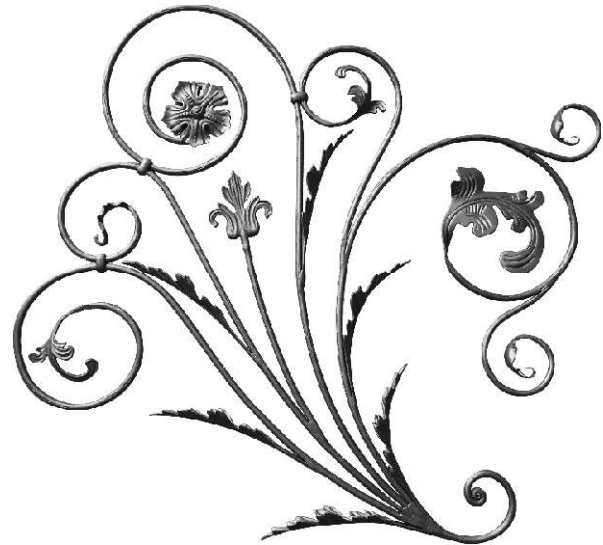

BxH: 800x880 Ø12

Ref. FAD038

# ADORNOS ORNAMENTS

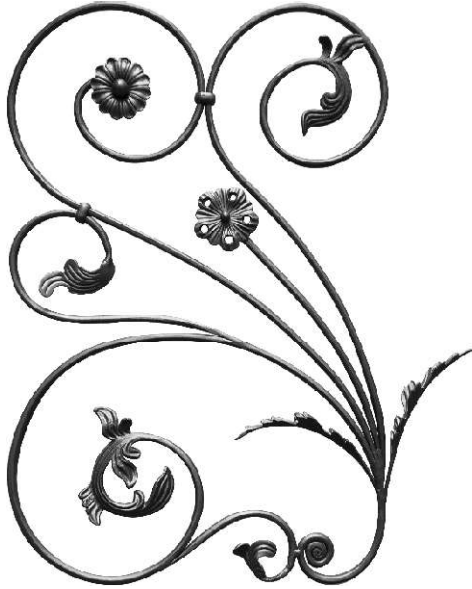

BxH:580x880Ø 12

Ref. FAD039

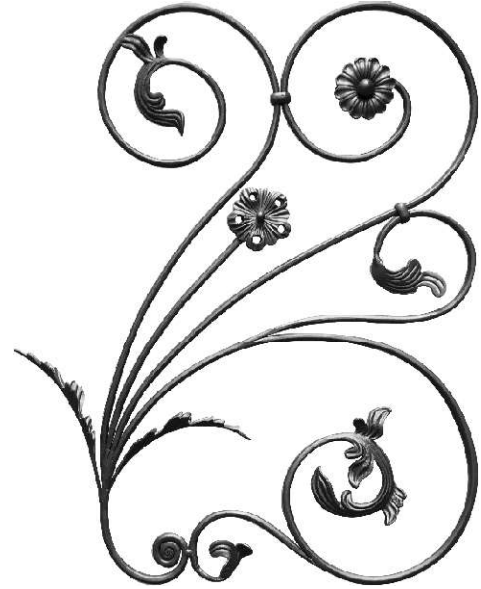

BxH:580x880Ø 12

Ref. FAD040

Mod. Patentado en CE

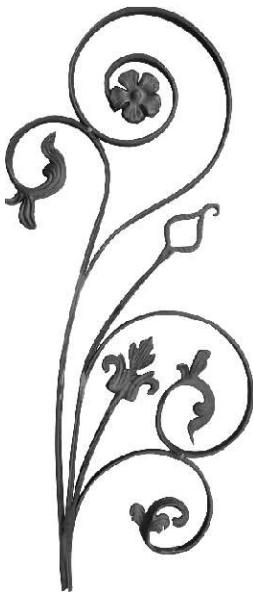

BxH:400x1000Ø 16x8

Ref. FAD041

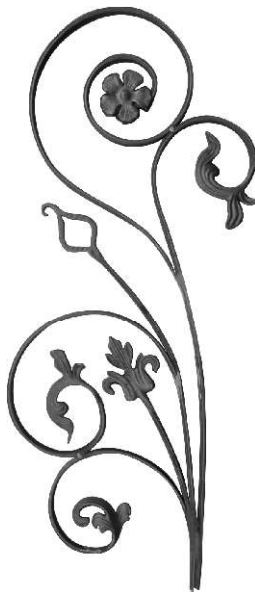

BxH:400x1000Ø 16x8

Ref. FAD042

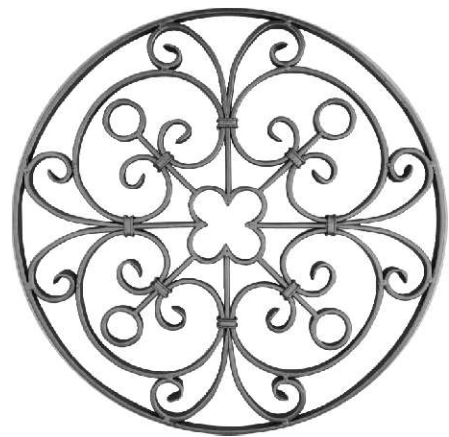

BxH:650x650Ø 16x8

Ref. FAD046



## P. DE LANZAS SPEARS



H:150Ø16

Ref. FLA001



H:130Ø12

Ref. FLA002



H:135Ø14

Ref. FLA003



H:160Ø16

Ref. FLA004



H:140Ø12

Ref. FLA005



H:135Ø12

Ref. FLA006



H:123

Ref. FLA007



H:150

Ref. FLA008



H:120

Ref. FLA009



H:155

Ref. FLA010



H:120

Ref. FLA011



H:160Ø16

Ref. FLA012

## P. DE LANZAS SPEARS



H:130Ø14

Ref. FLA013



H:140

Ref. FLA015



H:140

Ref. FLA016



H:120Ø16

Ref. FLA017



H:205

Ref. FLA018



H:125Ø32

Ref. FLA022



H:160Ø25

Ref. FLA023



H:210Ø20

Ref. FLA026



H:195Ø14;16

Ref. FLA014



H:200Ø14;16

Ref. FLA024



H:200Ø14;16

Ref. FLA025



BxH:85x150Ø2

Ref. FLA021

## P. DE LANZAS SPEARS



BxH: 109x104∅16x5

Ref. FLA019



BxH: 109x100∅16x5

Ref. FLA020



BxH: 125x236∅14x6

Ref. FLA027



BxH: 125x236∅14x6

Ref. FLA028

### LANZA DE CHAPA



BxH: 60x120∅3

Ref. LA030



# BARRAS TUBOS Y PLETINAS

## BARs TUBES & STRIPS



L:3000  $\varnothing$ 12;14;16;20

Ref. FPS005



L:3000  $\varnothing$ 20;30;40  
e:2mm

Ref. FPS006



L:3000  $\varnothing$ 20x30;20x40  
e:2mm

Ref. FPS006



L:2000  $\varnothing$ 14x4

Ref. FPS007

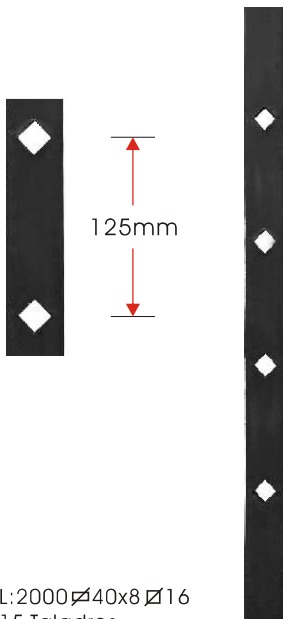

L:2000  $\varnothing$ 40x8  $\varnothing$ 16  
15 Taladros

Ref. FBP011

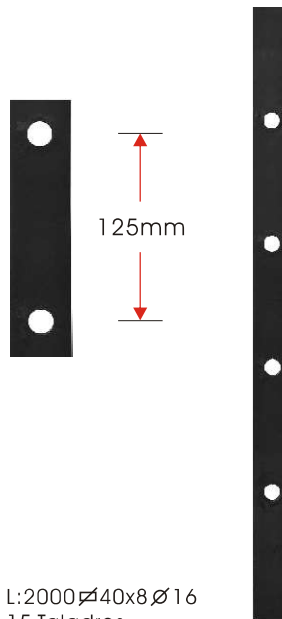

L:2000  $\varnothing$ 40x8  $\varnothing$ 16  
15 Taladros

Ref. FBP012

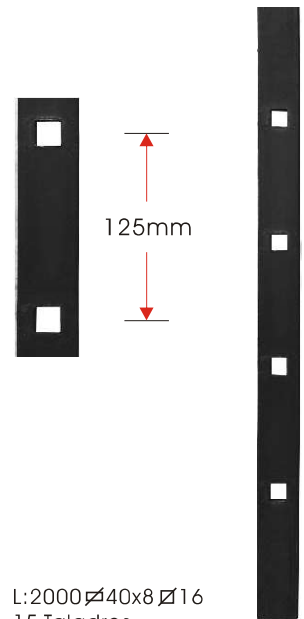

L:2000  $\varnothing$ 40x8  $\varnothing$ 16  
15 Taladros

Ref. FBP013

# BARRAS TUBOS Y PLETINAS

## BARS TUBES & STRIPS

Consultar plazo de entrega para cualquier otra medida.

We are able to supply different sizes; please consult our delivery schedules.

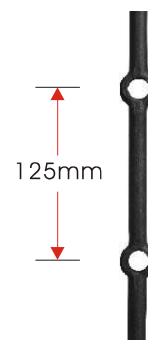
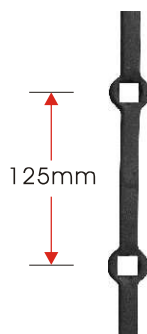
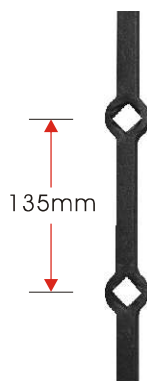
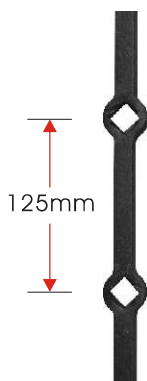

L:2000 (14Taladros)  
 Ø 14 T:14  
 Ø 16;18 T:16  
 Ø 20 T:16;18;20

Ref. FBP001

L:2000 (14Taladros)  
 Ø 14 T:14  
 Ø 16;20 T:16

Ref. FBP002

L:2000 (14Taladros)  
 Ø 14 T:14  
 Ø 16;20 T:16

Ref. FBP003

L:2000 (14Taladros)  
 Ø 14 T:14  
 Ø 16 T:16  
 Ø 20 T:20

Ref. FBP004

# BARRAS TUBOS Y PLETINAS

## BARS TUBES & STRIPS

Consultar plazo de entrega para cualquier otra medida.

We are able to supply different sizes; please consult our delivery schedules.

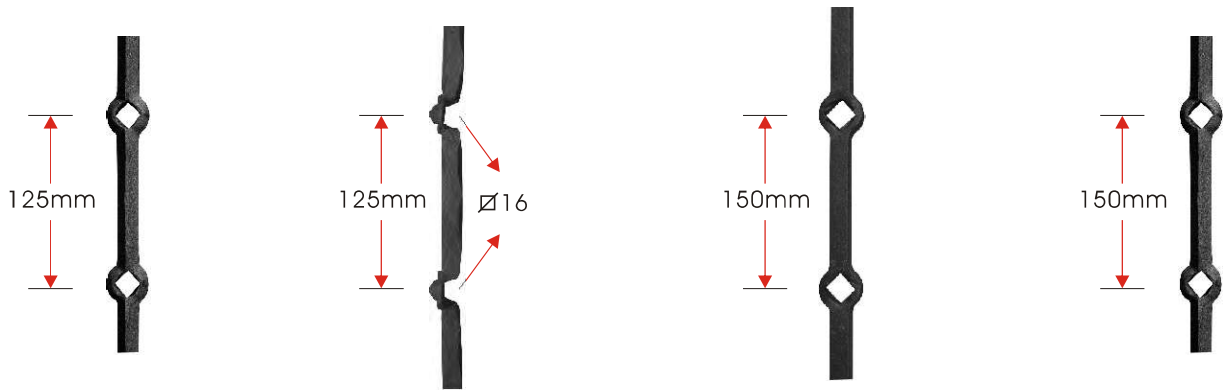

L:2000 (14Taladros)  
Ø16;20 T:16  
Ø20 T:20

Ref. FBP005

L:2000 Ø16

Ref. FBP006

L:2000 (13Taladros)  
Ø16 T:16

Ref. FBP007

L:2000 (13Taladros)  
Ø16 T:16

Ref. FBP009

# BARRAS TUBOS Y PLETINAS

## BARS TUBES & STRIPS



BxH:260x140  $\varnothing$  40x8

Ref. FPS002A



BxH:260x140  $\varnothing$  40x8

Ref. FPS003A



BxH:260x140  $\varnothing$  40x8

Ref. FPS009A



BxH:370x155  $\varnothing$  40x8

Ref. FPS002B



BxH:370x155  $\varnothing$  40x8

Ref. FPS003B



BxH:370x155  $\varnothing$  40x8

Ref. FPS009B



L:3000  $\varnothing$  40x8

Ref. FPS002



L:3000  $\varnothing$  40x8

Ref. FPS003



L:3000  $\varnothing$  40x8

Ref. FPS009

# BARRAS TUBOS Y PLETINAS

## BARS TUBES & STRIPS

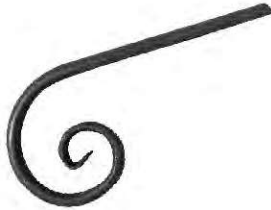

BxH: 250x145  $\varnothing$  50x14

Ref. FPS004A

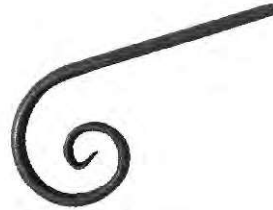

BxH: 250x145  $\varnothing$  40x10

Ref. FPS008A



BxH: 380x170  $\varnothing$  50x14

Ref. FPS004B



BxH: 380x170  $\varnothing$  40x10

Ref. FPS008B



L: 3000  $\varnothing$  50x14

Ref. FPS004



L: 3000  $\varnothing$  40x10

Ref. FPS008



# ARRANQUES DE ESCALERA STARTING POINTS FOR STAIRCASES



H: 1200  $\varnothing$  30  
Ref. FAR001



H: 1200  $\varnothing$  25  
Ref. FAR002



H: 1200  $\varnothing$  30  
Ref. FAR003



H: 1200  $\varnothing$  30  
Ref. FAR004



H: 1200  $\varnothing$  30  
Ref. FAR012

# ARRANQUES DE ESCALERA STARTING POINTS FOR STAIRCASES

Mod.  
Patentado en CE



H:1200 Ø25

Ref. FAR013



H:1200 Ø30

Ref. FAR016



H:1200 Ø25

Ref. FAR017



H:1200 Ø25

Ref. FAR018



H:1200 Ø25

Ref. FAR020

# ARRANQUES DE ESCALERA STARTING POINTS FOR STAIRCASES

Mod.  
Patentado en CE



H:1200Ø25  
Ref. FAR021

Mod.  
Patentado en CE



H:1200Ø25  
Ref. FAR022

Mod.  
Patentado en CE



H:1200Ø25  
Ref. FAR023

Mod.  
Patentado en CE



H:1200Ø25  
Ref. FAR024

Mod.  
Patentado en CE



H:1200Ø25  
Ref. FAR025

# BALAUSTRES BANISTERS



H: 1000 Ø14

Ref. FBA001A

H: 1000 Ø14

Ref. FBA001B

H: 1000 Ø14

Ref. FBA002A

H: 1000 Ø14

Ref. FBA002B

H: 1000 Ø14

Ref. FBA003A

# BALAUSTRES BANISTERS



H: 1000 Ø14

Ref. FBA003B

H: 1000 Ø14

Ref. FBA028A

H: 1000 Ø14

Ref. FBA028B

H: 1000 Ø14

Ref. FBA004A

H: 1000 Ø14

Ref. FBA011A

# BALAUSTRES BANISTERS

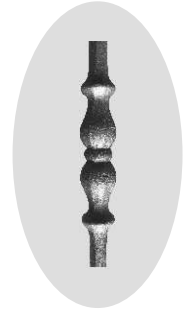
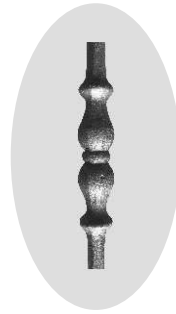
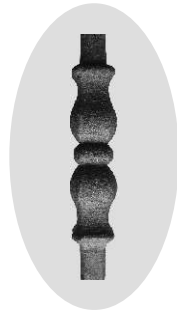
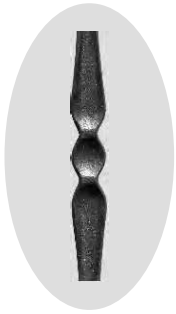

H:1000 Ø14

Ref. FBA011B

H:1000 Ø14

Ref. FBA012A

H:1000 Ø14

Ref. FBA012B

H:1000 Ø14

Ref. FBA029A

H:1000 Ø14

Ref. FBA029B

# BALAUSTRES BANISTERS



H: 1000 Ø14

Ref. FBA013A

H: 1000 Ø14

Ref. FBA013B

H: 1000 Ø14

Ref. FBA014A

H: 1000 Ø14

Ref. FBA014B

H: 1000 Ø14

Ref. FBA015A

# BALAUSTRES BANISTERS

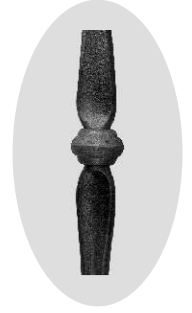
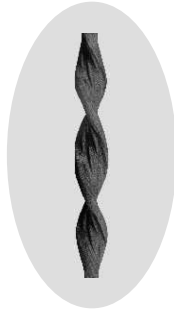
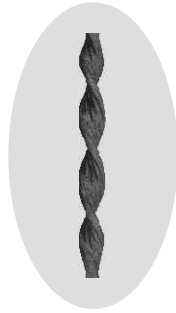

H:1000 Ø14

Ref. FBA015B

H:1000 Ø14

Ref. FBA016A

H:1000 Ø14

Ref. FBA016B

H:1000 Ø14

Ref. FBA017A

H:1000 Ø14

Ref. FBA017B



# BALAUSTRES BANISTERS

Mod.  
Patentado en CE

Mod.  
Patentado en CE

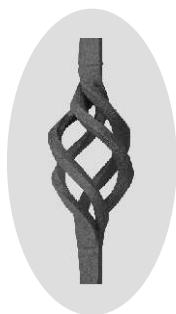

H:1000Ø14

Ref. FBA018A

H:1000Ø14

Ref. FBA018B

H:1000Ø20

Ref. FBA019A

H:1000Ø14

Ref. FBA020A

H:1000Ø14

Ref. FBA020B

# BALAUSTRES BANISTERS

Mod.  
Patentado en CE



Mod.  
Patentado en CE



Mod.  
Patentado en CE



Mod.  
Patentado en CE



Mod.  
Patentado en CE



H:1000Ø14

Ref. FBA021A

H:1000Ø14

Ref. FBA021B

H:1000Ø14

Ref. FBA022A

H:1000Ø14

Ref. FBA022B

H:1000Ø14

Ref. FBA023A

# BALAUSTRES BANISTERS

Mod.  
Patentado en CE



Mod.  
Patentado en CE



Mod.  
Patentado en CE



Mod.  
Patentado en CE



Mod.  
Patentado en CE



H:1000Ø14

Ref. FBA023B

H:1000Ø14

Ref. FBA024A

H:1000Ø14

Ref. FBA024B

H:1000Ø14

Ref. FBA025A

H:1000Ø14

Ref. FBA025B

# BALAUSTRES BANISTERS

Mod.  
Patentado en CE



Mod.  
Patentado en CE

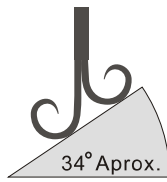

Mod.  
Patentado en CE



Mod.  
Patentado en CE

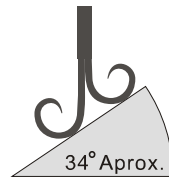

BxH: 125x900 Ø14  
Ref. FBA026



BxH: 125x885 Ø14  
Ref. FBA026E



BxH: 125x900 Ø14  
Ref. FBA027



BxH: 125x885 Ø14  
Ref. FBA027E



H: 1000 Ø12  
Ref. FBA054A

# BALAUSTRES BANISTERS



H:1000 Ø12

Ref. FBA054B



H:1000 Ø14

Ref. FBA055A



H:1000 Ø14

Ref. FBA055B



H:1000 Ø14

Ref. FBA056A



H:1000 Ø14

Ref. FBA056B

# BALAUSTRES BANISTERS



H:1000 Ø14

Ref. FBA057A



H:1000 Ø14

Ref. FBA057B



H:1000 Ø14

Ref. FBA058A



H:1000 Ø14

Ref. FBA058B



H:1000 Ø14

Ref. FBA059

# BALAUSTRÉS BANISTERS



BxH: 120x1000 Ø16

Ref. FBA064



BxH: 120x1000 Ø16

Ref. FBA065



H: 600 Ø16

Ref. FBA060



BxH: 180x1000 Ø12

Ref. FBA005



BxH: 240x1000 Ø12; 16

Ref. FBA006



BxH: 155x1000 Ø12; 16

Ref. FBA007

# BALAUSTRÉS BANISTERS



BxH: 180x1000 Ø14

Ref. FBA030



BxH: 205x1000 Ø14

Ref. FBA031



BxH: 135x1000 Ø14

Ref. FBA032



BxH: 165x1000 Ø14

Ref. FBA033



BxH: 135x1000 Ø14

Ref. FBA034



H: 1000 Ø14

Ref. FBA066A



H: 1000 Ø14

Ref. FBA066B

Mod. Patentado en CE



BxH: 255x1000 Ø12

Ref. FBA035



# BALAUSTRES BANISTERS

Mod. Patentado en CE

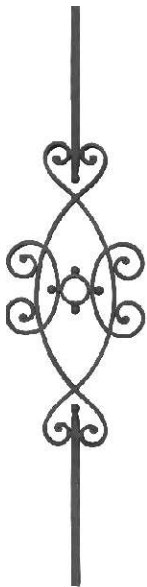

BxH: 230x1000  $\varnothing$ 16

Ref. FBA036

Mod. Patentado en CE



BxH: 265x1000  $\varnothing$ 20x8

Ref. FBA037

Mod. Patentado en CE



BxH: 265x1000  $\varnothing$ 20x8

Ref. FBA038

Mod. Patentado en CE



BxH: 220x1000  $\varnothing$ 12

Ref. FBA039



BxH: 210x1000  $\varnothing$ 14

Ref. FBA067



BxH: 250x1000  $\varnothing$ 14

Ref. FBA068



BxH: 225x1000  $\varnothing$ 14

Ref. FBA069



BxH: 153x1000  $\varnothing$ 14

Ref. FBA072

# BALAUSTRES BANISTERS



BxH:200x1000Ø14

Ref. FBA070



BxH:200x1000Ø14

Ref. FBA071



BxH:180x1000Ø14

Ref. FBA073



BxH:150x1000Ø14

Ref. FBA074



BxH:150x1000Ø14

Ref. FBA075



BxH:210x1000Ø14

Ref. FBA076

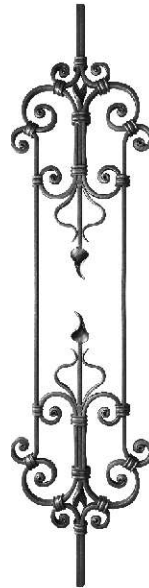

BxH:230x1000Ø14

Ref. FBA077

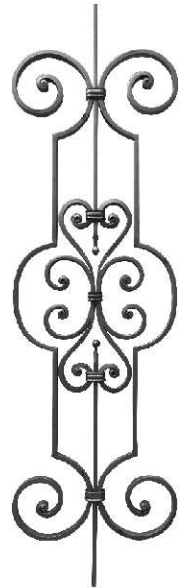

BxH:290x1000Ø16x8

Ref. FBA078

# BALAUSTRES BANISTERS

Mod. Patentado en CE

Mod. Patentado en CE



BxH: 260x1000  $\varnothing$ 14

Ref. FBA079

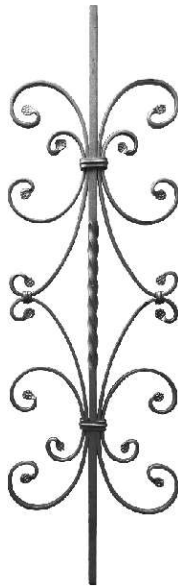

BxH: 290x1000  $\varnothing$ 14

Ref. FBA080

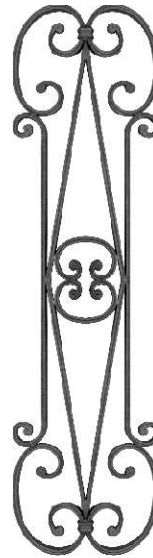

BxH: 240x900  $\varnothing$ 16x8

Ref. FBA041



BxH: 160x900  $\varnothing$ 14

Ref. FBA043

Mod. Patentado en CE

Mod. Patentado en CE

Mod. Patentado en CE

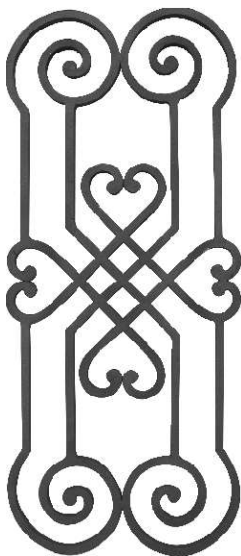

BxH: 390x900  $\varnothing$ 14

Ref. FBA040

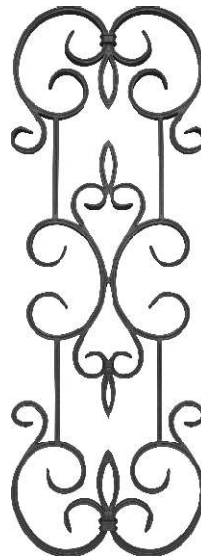

BxH: 310x900  $\varnothing$ 16x8

Ref. FBA042



BxH: 260x900  $\varnothing$ 16x8

Ref. FBA088

# BALAUSTRÉS BANISTERS

Mod. Patentado en CE

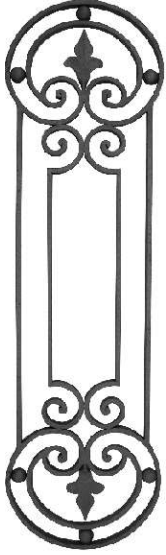

BxH: 255x900  $\varnothing$ 16x8

Ref. FBA044

Mod. Patentado en CE



BxH: 252x900  $\varnothing$ 16x8

Ref. FBA086

Mod. Patentado en CE



BxH: 250x900  $\varnothing$ 16x6

Ref. FBA087

Mod. Patentado en CE

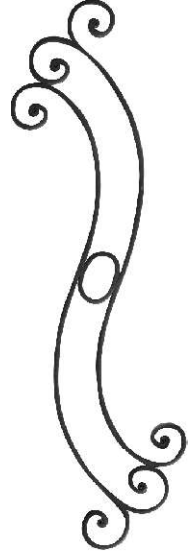

BxH: 210x870  $\varnothing$ 20x8

Ref. FBA045E



BxH: 220x900  $\varnothing$ 12

Ref. FBA046



BxH: 220x900  $\varnothing$ 12

Ref. FBA046E

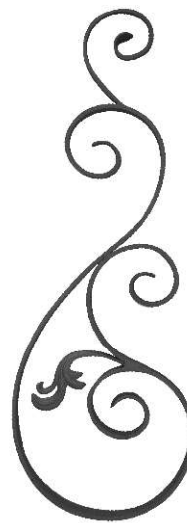

BxH: 250x700  $\varnothing$ 20x6

Ref. FBA051



BxH: 240x720  $\varnothing$ 20x6

Ref. FBA052

# BALAUSTRÉS BANISTERS

Mod. Patentado en CE

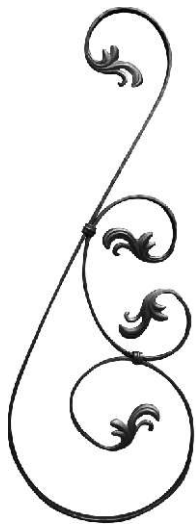

BxH:295x800∅12x6

Ref. FBA081



BxH:350x870∅14

Ref. FBA048



BxH:350x870∅14

Ref. FBA049

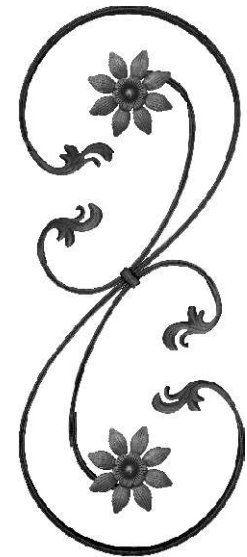

BxH:350x870∅16x8

Ref. FBA050

Mod. Patentado en CE

Mod. Patentado en CE

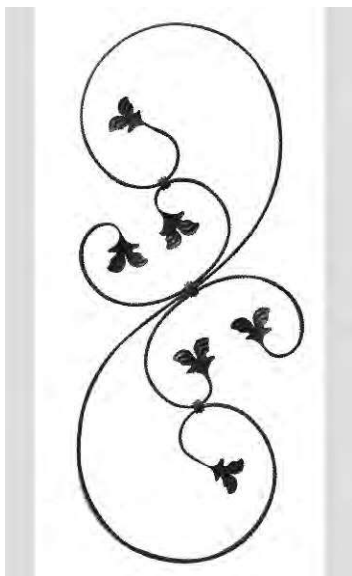

BxH:350x870∅12x6

Ref. FBA009



BxH:350x870∅12x6

Ref. FBA053

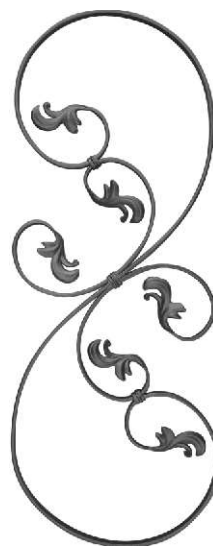

BxH:350x870∅12x6

Ref. FBA082



BxH:328x870∅16x8

Ref. FBA089

# BALAUSTRÉS BANISTERS

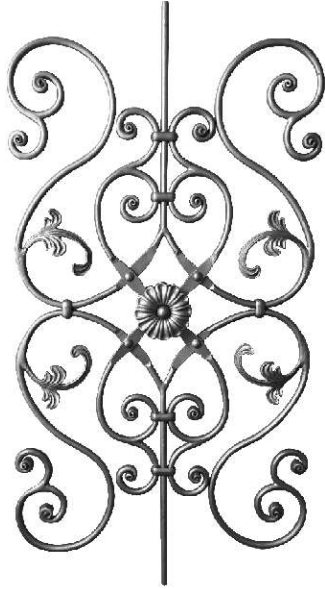

BxH:480x930Ø12

Ref. FBA083



BxH:480x970Ø12

Ref. FBA083E

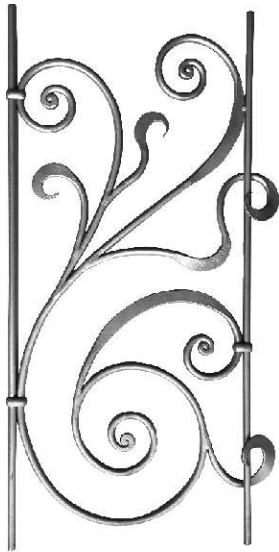

BxH:465x920Ø14

Ref. FBA084



BxH:465x1160Ø14

Ref. FBA084E

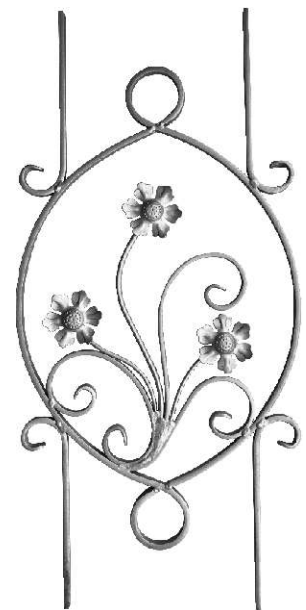

BxH:390x800Ø14x8

Ref. FBA085

# BALAUSTRES BANISTERS



BxH:210x950Ø14

Ref. FBA061



BxH:210x950Ø14

Ref. FBA062



BxH:210x950Ø14

Ref. FBA063



## SOLERAS BORDERS

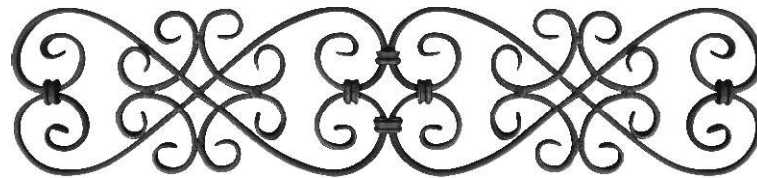

Mod. Patentado LxH:800x180  $\varnothing$  16x6

Ref. FSO001

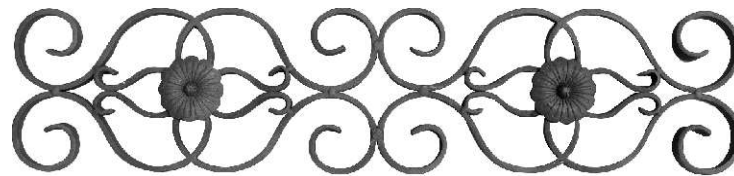

Mod. Patentado LxH:800x180  $\varnothing$  16x6

Ref. FSO002

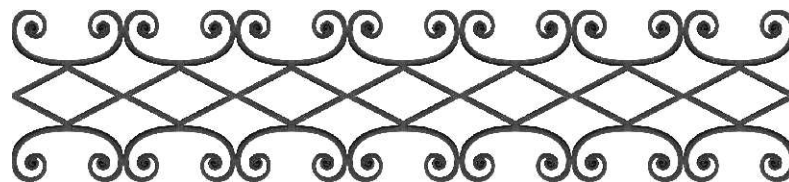

Mod. Patentado en CE LxH:805x180  $\varnothing$  16x5

Ref. FSO003

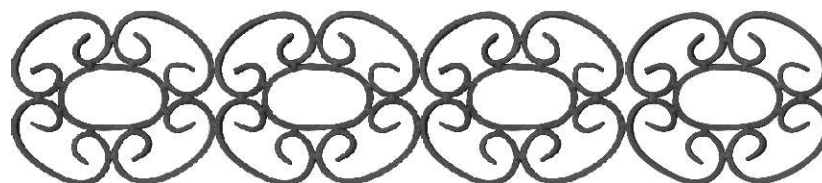

Mod. Patentado en CE LxH:840x180  $\varnothing$  16x6

Ref. FSO004



## SOLERAS BORDERS

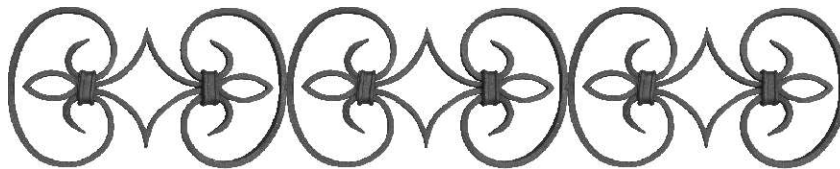

Mod. Patentado en CE LxH:840x160  $\varnothing$  16x6

Ref. FSO005

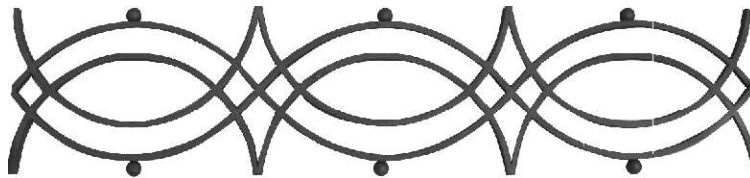

LxH:750x170  $\varnothing$  16x6

Ref. FSO006

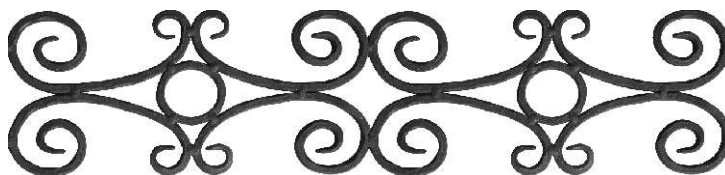

Mod. Patentado en CE LxH:800x180  $\varnothing$  10

Ref. FSO007



Mod. Patentado en CE LxH:800x180  $\varnothing$  16x5

Ref. FSO008

# SOLERAS BORDERS

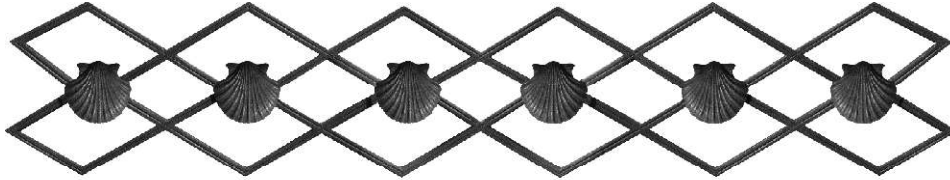

Mod. Patentado en CE LxH:895x160  $\varnothing$  16x8

Ref. FSO009

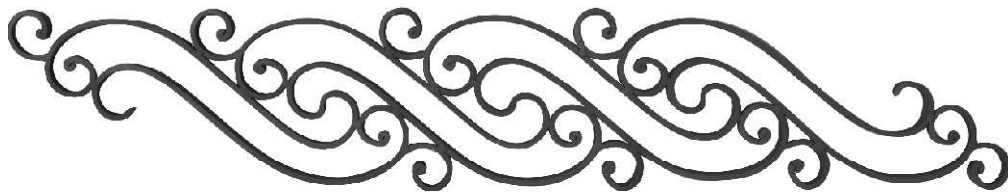

Mod. Patentado en CE LxH:1000x180  $\varnothing$  16x5

Ref. FSO010



LxH:900x130  $\varnothing$  12

Ref. FSO011



LxH:360x80

Ref. FSO012



LxH:690x100  $\varnothing$  16x8

Ref. FSO013

# PENACHOS Y MÉNSULAS BRACKETES



Mod. Patentado en CE BxH:1000x280x16x8

Ref. FPE001



BxH:135x450

Ref. FME001



Mod. Patentado en CE BxH:900x260x16x8

Ref. FPE002



BxH:135x450

Ref. FME003



Mod. Patentado en CE BxH:800x260x20x6

Ref. FPE003



BxH:135x450

Ref. FME004

# PENACHOS Y MÉNSULAS BRACKETES



BxH: 135x450

Ref. FME017



BxH: 900x250  $\varnothing$ 20x6

Ref. FPE004

Mod. Patentado en CE



BxH: 135x450

Ref. FME023

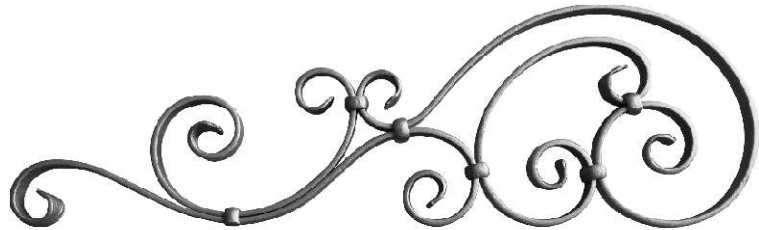

BxH: 760x225  $\varnothing$ 20x6

Ref. FPE005

Mod. Patentado en CE



BxH: 135x450

Ref. FME025



BxH: 1100x330  $\varnothing$ 20x6

Ref. FPE006

# PENACHOS Y MÉNSULAS BRACKETES

Mod. Patentado en CE



BxH: 650x126  $\varnothing$ 16x8

Ref. FPE007



BxH: 130x450

Ref. FME012



Ref. FS006



H: 300  $\varnothing$ 16x8

Ref. FS006



BxH: 135x450

Ref. FME013

Mod. Patentado



BxH: 435x280  $\varnothing$ 16x6

Ref. FAC009

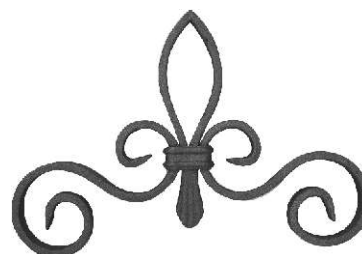

BxH: 254x175  $\varnothing$ 16x6

Ref. FAC010

# ADORNOS DE CANCELAS GATE ORNAMENTS

Mod. Patentado



BxH: 180x400  $\varnothing$  16x6

Ref. FAC003

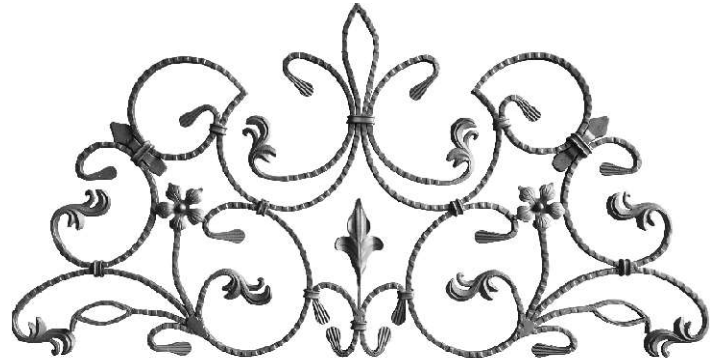

Mod. Patentado BxH: 1150x590  $\varnothing$  16x8

Ref. FAC001

Mod. Patentado



BxH: 180x400  $\varnothing$  16x6

Ref. FAC004

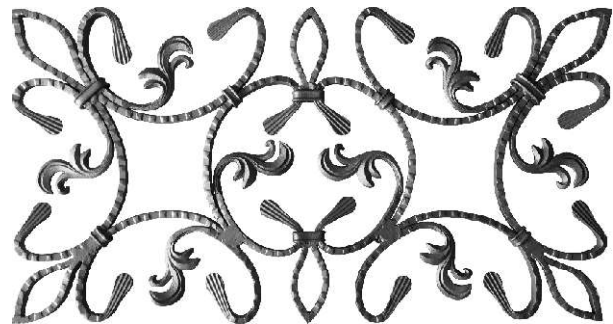

Mod. Patentado BxH: 770x400  $\varnothing$  16x8

Ref. FAC002

Mod. Patentado en CE

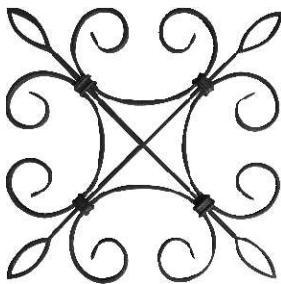

BxH: 400x400  $\varnothing$  20x6

Ref. FAC007

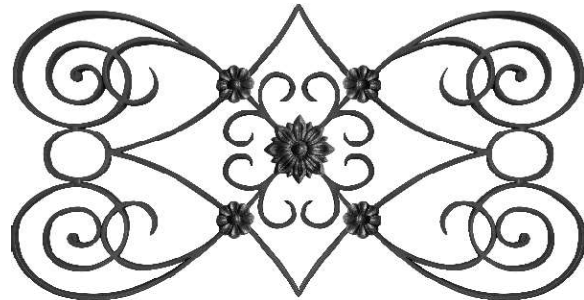

Mod. Patentado en CE BxH: 750x380  $\varnothing$  25x6

Ref. FAC006

## ADORNOS DE CANCELAS GATE ORNAMENTS

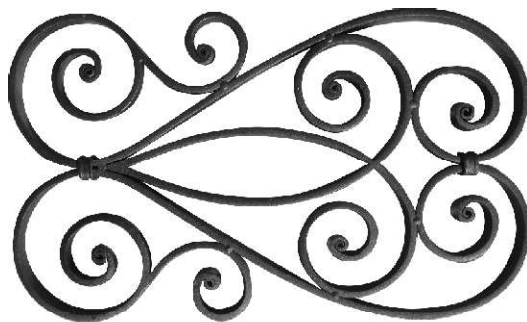

Mod. Patentado en CE BxH: 580x340  $\varnothing$ 25x6

Ref. FAC008



Mod. Patentado en CE BxH: 1000x400  $\varnothing$ 16x8

Ref. FAC011

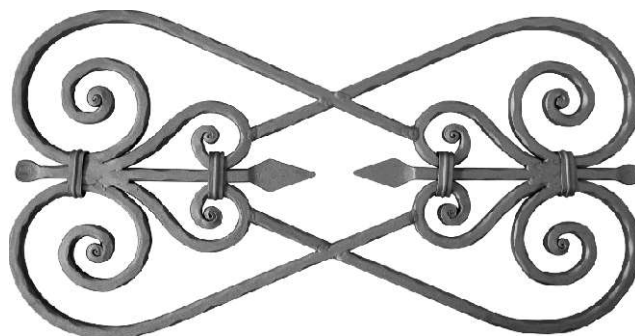

Mod. Patentado en CE BxH: 750x380  $\varnothing$ 14

Ref. FAC012

# HERRAJES IRONWORKS



REF.	Base (mm)	H (mm)
73325	25x25	30
73330	30x30	30
73335	35x35	30



REF.	Base (mm)	H (mm)
73435	30x30	30
73440	40x40	30



REF.	Base (mm)	H (mm)
73705	25	24
73706	30	24
73707	35	24
73708	40	24



REF.	Base (mm)	H (mm)
73725	25	30
73730	30	30
73735	35	30
73740	40	30
73760	60	40
73780	80	40



REF.	Base (mm)	H (mm)
73781	25	30
73782	30	30
73783	35	30
73784	40	30



REF.	Base (mm)	H (mm)
73791	25	24
73792	30	24
73793	35	24
73794	40	24



# HERRAJES IRONWORKS



B:  $\varnothing$ 60

Ref. 73072-B



BxH:  $\varnothing$ 35x30

Ref. 73080



BxH:  $\varnothing$ 35x30

Ref. 73081



BxH: 160x143

Ref. 73103D;I



BxH: 166x147

Ref. 73105D;I



BxH: 166x130

Ref. 73109



BxH: 182x130

Ref. 73111



BxH: 130x280

Ref. 73120



BxH: 130x120

Ref. 73121



BxH: 130x $\varnothing$ 60

Ref. 73122



BxH: 130x280

Ref. 73130



BxH: 130x120

Ref. 73131

OTROS - forja

# HERRAJES IRONWORKS



BxH: 130xØ60

Ref. 73132



BxH: 130x280

Ref. 73140



BxH: 130x120

Ref. 73141



BxH: 130xØ60

Ref. 73142



BxH: 130x280

Ref. 73160



BxH: 130x120

Ref. 73161



BxH: 130xØ60

Ref. 73162



BxH: 130x120

Ref. 73171



BxH: 130xØ60

Ref. 73172

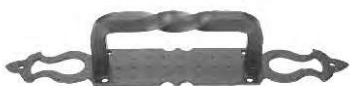

BxH: 280x45

Ref. 73001



BxH: 150x30

Ref. 73871



BxH: 140x30

Ref. 73872

# HERRAJES IRONWORKS



BxH:130x275

Ref. 73173



BxH:45x280

Ref. 73002

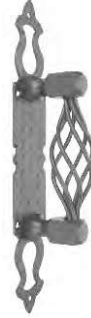

BxH:45x280

Ref. 73004



BxH:Ø60x240

Ref. 73025



BxH:Ø60x260

Ref. 73026



BxH:60x197

Ref. 73034

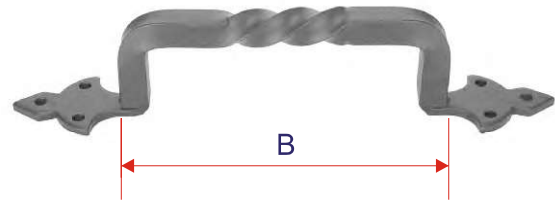

BxH:140; 180; 240 x 43

Ref. 73029; 73030; 73031



BxH:Ø65x280

Ref. 73056



BxH:Ø75x75

Ref. 73050



BxH:Ø75x42

Ref. 73051



BxH:Ø75x80

Ref. 73052

# HERRAJES IRONWORKS



BxH: Ø80x75

Ref. 73054



BxH: 125x65

Ref. 73211



BxH: Ø40x50

Ref. 73212



BxH: 250x90

Ref. 73280



BxH: 200x90

Ref. 73282

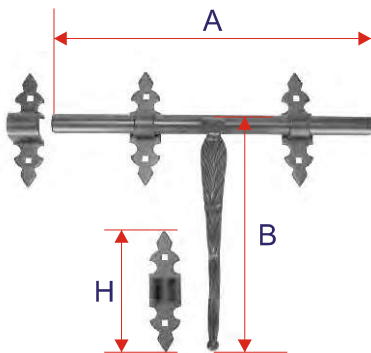

REF.	A (mm)	B (mm)	H (mm)
73283	400	280	110
73284	500	280	110
73285	600	280	110



REF.	B (mm)	H (mm)
73920	35	150
73921	35	200
73922	35	250
73923	35	300
73924	35	400
73925	35	500



REF.	B (mm)	H (mm)
73985	65	42
73986	80	42
73987	95	46
73988	106	47

# HERRAJES IRONWORKS



BxH:  $\varnothing$ 105x280

Ref. 73200



BxH:90x200

Ref. 73202



BxH:70x115

Ref. 73408



BxH:100; 125 x 27

Ref. 73620-B; 73621-B



BxH:100; 125 x 27

Ref. 73620-N; 73621-N



BxH:140x30

Ref. 73873



Base:95x35; 65x25

Ref. 73953; 73955



BxH:35x95; 25x65

Ref. 73954; 73956



BxH:95x35; 65x25

Ref. 73957; 73959



BxH:35x95; 25x65

Ref. 73958; 73960



BxH:95x35

Ref. 73961



BxH:65x80

Ref. 73952

# HERRAJES IRONWORKS



BxH: 140x80

Ref. 73950



BxH: 115x35

Ref. 73951



BxH: 77x65

Ref. 73210



BxH: 130x100

Ref. 74002

REF.	B (mm)	H (mm)
74053	100	200
74054	100	250
74055	100	300



REF.	B (mm)	H (mm)
74050	300	200
74051	350	250
74052	400	300



REF.	B (mm)	H (mm)
74111-B	173	90
74112-B	193	90
74113-B	218	90



REF.	B (mm)	H (mm)
74111-N	173	90
74112-N	193	90
74113-N	218	90

# HERRAJES IRONWORKS



REF.	B (mm)	H (mm)
74065	200	200
74066	250	250
74067	300	300

REF.	B (mm)	H (mm)
73305	200	250
73306	250	300
73307	300	350
73308	350	400

REF.	B (mm)	H (mm)
82011-N	100	75
82012-N	150	115
82013-N	200	150
82014-N	250	200



BxH:120x29

Ref. 74100



BxH:200; 300; 400 x 20

Ref. 74101; 74102; 74103



H:100

Ref. 76130-N



H:100

Ref. 76131-N



H:100

Ref. 76132-N

# HERRAJES IRONWORKS

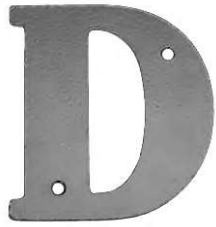

H:100

Ref. 76133-N



H:100

Ref. 76134-N



H:100

Ref. 76120-N



H:100

Ref. 76121-N



H:100

Ref. 76122-N



H:100

Ref. 76123-N



H:100

Ref. 76124-N



H:100

Ref. 76125-N



H:100

Ref. 76126-N



# HERRAJES IRONWORKS



H:100

Ref. 76127-N



H:100

Ref. 76128-N



H:100

Ref. 76129-N

ABCDEFGHIJKLMNOPQRSTUVWXYZ  
abcdefghijklmnopqrstuvwxyz  
1 2 3 4 5 6 7 8 9 0

A B C D E F G H

Podemos suministrar cualquier tipo y tamaño de letra y numero.

Ref. LETRAS ; NUMEROS

